

# Data Sheet



Article number: 021816011152

Description: Clamp with bracket and rubber  
SPGU 6011. 152/30 SK

## Measures

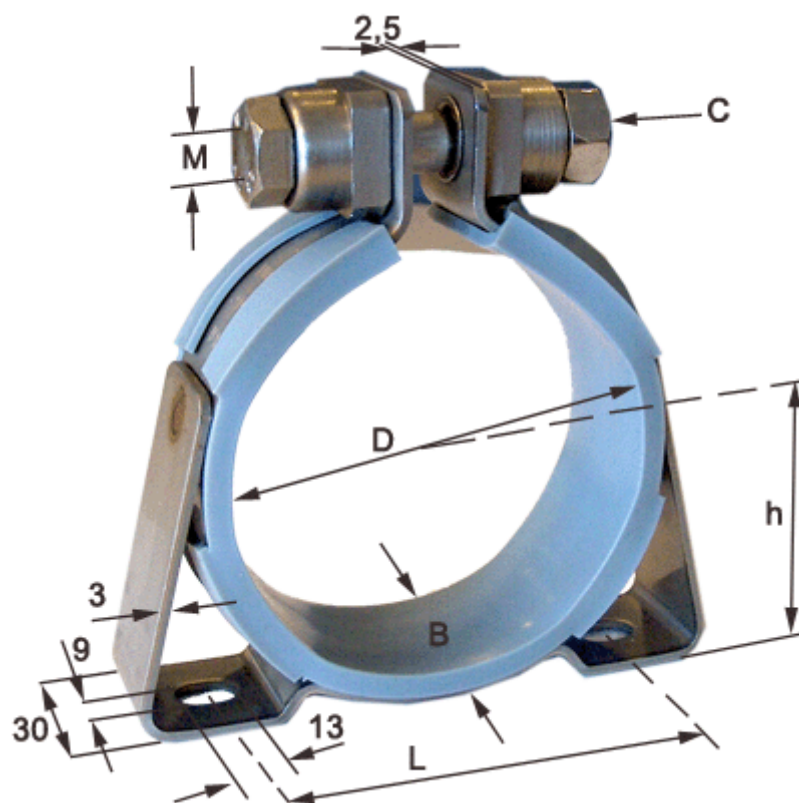

C (screw type) = SK hexagon screw

Diameter D = 152

h = 84

L = 148

Width B = 30